

SIEMENS

电动机控元器件产品目录

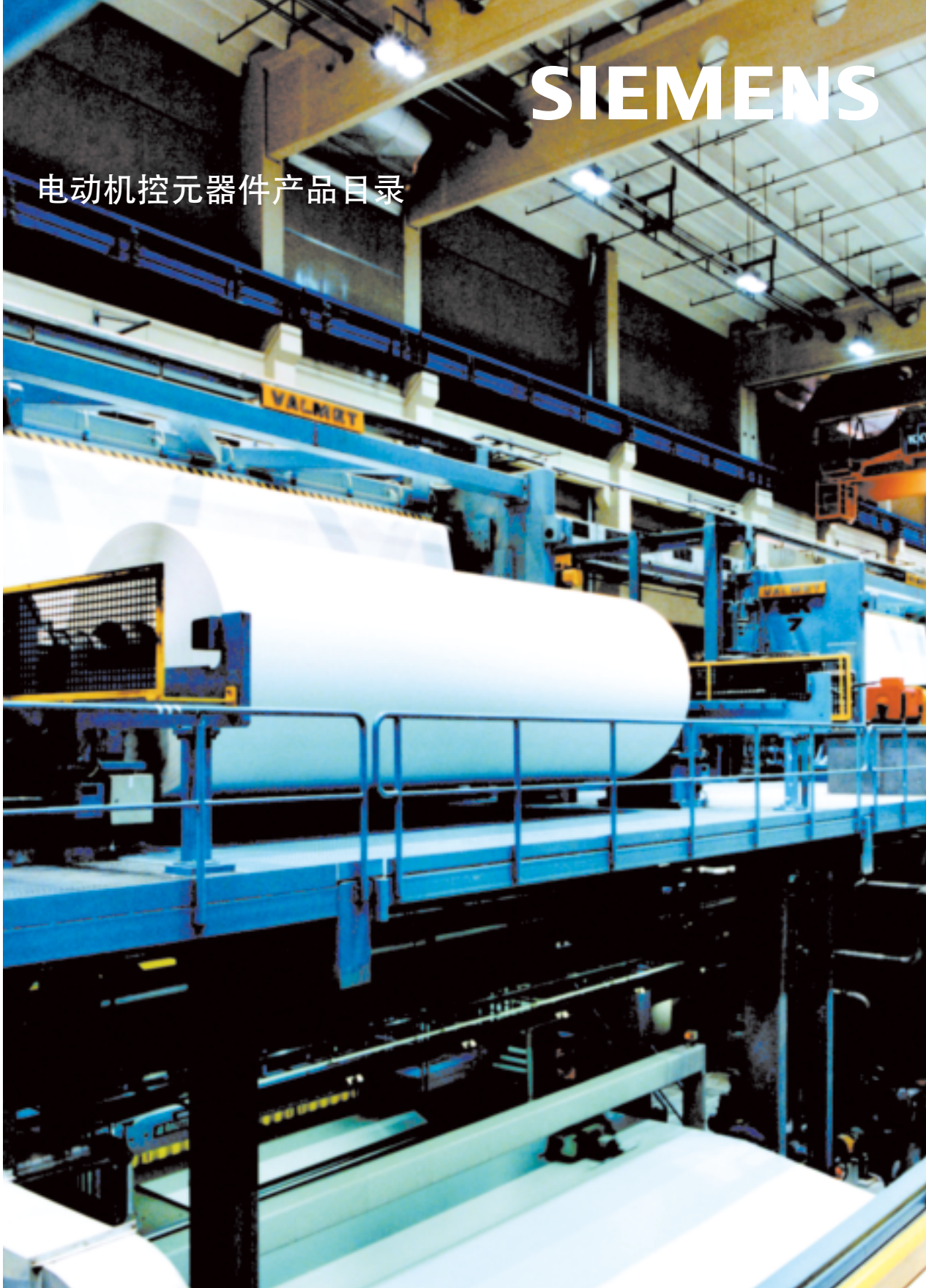

低压控制产品与系统

Answers for industry.

深圳木村三浦科技有限公司



4008 824 824
WWW.SANPUM.COM

3TF交流接触器

说明

3TF 系列交流接触器用于交流 50Hz 或 60Hz，额定绝缘电压为 690-1000V，在 AC-3 使用类别下额定工作电压为 380V 时的额定工作电流为 9A-400A。主要供远距离接通及分断电路之用，适用于控制交流电动机的起动、停止及反转。符合 IEC947, VDE0660, GB14048 等标准。

工作条件

- 海拔高度不超过 2000 米；
- 周围环境温度：-25 ~ +55°C；
- 空气相对湿度：在 +40°C 时不超过 50%，+25°C 时不超过 90%；
- 大气条件：没有会引起爆炸危险的介质，也没有腐蚀金属和破坏绝缘的气体 and 导电尘埃；
- 在无显著摇动和冲击振动的地方；
- 在没有雨雪侵袭的地方。

结构特点





- 安全性能好，导电部件不外露；
- 体积小，重量轻，灭弧罩材料采用不饱和树脂，耐弧性好，不会碎裂；
- 灭弧室呈封闭型，飞弧距离小，可缩小电气箱体尺寸；
- 主触头系统结构独特，触头磨损小，电寿命增加；
- 电磁铁工作可靠，损耗少，噪音小，且具有很高的机械强度；
- 操作频率和控制容量高；
- 3TF30-35 系列可外加辅助触头座；
- SIGUT- 西门子专利端接法，接线方便，牢固，接触可靠性高，抗振性强，安全防护性好。

低压控制产品与系统

接触器和接触器组合

3TF交流接触器



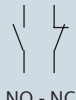
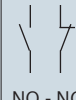
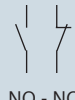
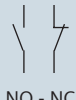





选型与订货数据

交流操作							
辅助触头 NO 常开 NC 常闭							
订货号		3TF30 00 - 0X 3TF30 10 - 0X 3TF30 01 - 0X	3TF40 10 - 0X 3TF40 01 - 0X 3TF40 11 - 0X 3TF40 22 - 0X 3TF40 20 - 0X 3TF40 31 - 0X	3TF31 00 - 0X 3TF31 10 - 0X 3TF31 01 - 0X	3TF41 10 - 0X 3TF41 01 - 0X 3TF41 11 - 0X 3TF41 22 - 0X 3TF41 20 - 0X 3TF41 31 - 0X		
额定绝缘电压 (V)		690	690	690	690		
额定工作电流 (A) (380V)		AC - 3 9 AC - 4 3.3	9 3.3	12 4.3	12 4.3		
可控电机功率 (KW) 50Hz	AC - 3	230/220V 400/380V 500 V 690/660V 1000 V	2.4 4 5.5 5.5 --	2.4 4 5.5 5.5 --	3.3 5.5 7.5 7.5 --		
	AC - 4	400/380V 690/660V	1.48/1.4 2.54/2.4	1.48/1.4 2.54/2.4	2/1.9 3.45/3.3		
机械寿命 (x10 ⁶)		15	15	15	15		
电寿命 (x10 ⁶)		AC - 3 1.2 AC - 4 0.2	1.2 0.2	1.2 0.2	1.2 0.2		
操作频率 (1/h)		AC - 3 1000 AC - 4 250	1000 250	1000 250	1000 250		
吸引线圈工作电压范围 (AC)		(0.8~1.1)U _s					
线圈电压订货号		50Hz 线圈		60Hz 线圈		50/60Hz 线圈	
3TF3...-0X □□ 3TF4...-0X □□		50Hz	60Hz	60Hz	50Hz		
		24V	29V	B0	24V	20V	C1
		32V	38V	C0	110V	92V	G1
		36V	42V	G0	115V	96V	J1
		42V	50V	D0	120V	100V	K1
		48V	58V	H0	208V	173V	M1
		60V	72V	E0	220V	183V	N1
		110V	132V	F0	230V	192V	L1
		125/127V	150/152V	L0	240V	200V	P1
		220V	264V	M0	440V	367V	R1
		230V	277V	P0	575V	480V	S1
		240V	288V	U0			
		380V	460V	Q0			
		400V	480V	V0			
		415V	500V	R0			
		500V	600V	S0			
吸引线圈功率消耗		保持 (VA)	7.8	7.8	7.8	7.8	7.8
		功率因数 p.f.	0.29	0.29	0.29	0.29	0.29
		吸合 (VA)	68	68	68	68	68
		功率因数 p.f.	0.82	0.82	0.82	0.82	0.82
约定发热电流 (A)		20	20	20	20	20	20
辅助触头约定发热电流 (A)		10	10	10	10	10	10
辅助触头额定绝缘电压 (V)		690	690	690	690	690	690
辅助触头额定工作电流 (A)		AC - 15 380/220V DC - 13 110/220V	6/10 0.9/0.45	6/10 0.9/0.45	6/10 0.9/0.45	6/10 0.9/0.45	6/10 0.9/0.45
重量 (kg)		0.37	0.43	0.37	0.43	0.37	0.43

注：用于 3TF3 系列的 3TX4 辅助触头座见第 2/19 页

3TF交流接触器

选型与订货数据

交流操作							
辅助触头 NO 常开 NC 常闭							
订货号		3TF32 00 - 0X 3TF32 11 - 0X	3TF42 10 - 0X 3TF42 11 - 0X 3TF42 20 - 0X 3TF42 22 - 0X	3TF33 00 - 0X 3TF33 11 - 0X	3TF43 10 - 0X 3TF43 11 - 0X 3TF43 20 - 0X 3TF43 22 - 0X		
额定绝缘电压 (V)		690	690	690	690		
额定工作电流 (A) (380V)		AC - 3 AC - 4	16 7.7	22 8.5	22 8.5		
可控电机功率 (KW) 50Hz	AC - 3	230/220V 400/380V 500 V 690/660V 1000 V	4 7.5 9 11 --	4 7.5 9 11 --	5.5 11 11 11 --		
	AC - 4	400/380V 690/660V	3.5 6	3.5 6	4 6.6		
机械寿命 (x10 ⁶)		15	15	15	15		
电寿命 (x10 ⁶)		AC - 3 AC - 4	1.2 0.2	1.2 0.2	1.2 0.2		
操作频率 (1/h)		AC - 3 AC - 4	750 250	750 250	750 250		
吸引线圈工作电压范围 (AC)		(0.8~1.1)U _s					
线圈电压订货号		50Hz 线圈		60Hz 线圈		50/60Hz 线圈	
3TF3...-0X □□ 3TF4...-0X □□		50Hz	60Hz	60Hz	50Hz	24V	C2
		24V	29V	24V	20V	42V	D2
		32V	38V	110V	92V	110V	G2
		36V	42V	115V	96V	115V	J2
		42V	50V	120V	100V	120V	K2
		48V	58V	208V	173V	208V	M2
		60V	72V	220V	183V	220V	N2
		110V	132V	230V	192V	230V	L2
		125/127V150/152V	L0	240V	200V	240V	P2
		220V	264V	440V	367V	440V	R2
		230V	277V	575V	480V	575V	S2
		240V	288V				
		380V	460V				
		400V	480V				
		415V	500V				
		500V	600V				
吸引线圈功率消耗 (50Hz)		保持 (VA) 功率因数 p.f. 吸合 (VA) 功率因数 p.f.	7.8 0.29 68 0.82	7.8 0.29 68 0.82	7.8 0.29 68 0.82	7.8 0.29 68 0.82	7.8 0.29 68 0.82
约定发热电流 (A)		30	30	30	30	30	30
辅助触头约定发热电流 (A)		10	10	10	10	10	10
辅助触头额定绝缘电压 (V)		690	690	690	690	690	690
辅助触头额定工作电流 (A)		AC - 15 380/220V DC - 13 110/220V	4/6 1.14/0.48	6/10 0.9/0.45	4/6 1.14/0.48	6/10 0.9/0.45	6/10 0.9/0.45
重量 (kg)		0.45	0.49	0.45	0.49	0.45	0.49









注：用于 3TF3 系列的 3TX4 辅助触头座见第 2/19 页

低压控制产品与系统

接触器和接触器组合

3TF交流接触器









选型与订货数据

交流操作									
辅助触头 NO 常开 NC 常闭									
订货号		3TF34 00 - 0X 3TF34 11 - 0X	- - 1 1	3TF44 11 - 0X 3TF44 22 - 0X	1 1 2 2	3TF35 00 - 0X 3TF35 11 - 0X	- - 1 1	3TF45 11 - 0X 3TF45 22 - 0X	1 1 2 2
额定绝缘电压 (V)		690		690		690		690	
额定工作电流 (A) (380V)		AC - 3	32	32	38	38			
		AC - 4	15.6	15.6	18.5	18.5			
可控电机功率 (KW) 50Hz	AC - 3	230/220V	8.5	8.5	11	11			
		400/380V	15	15	18.5	18.5			
		500 V	21	21	25	25			
	AC - 4	690/660V	23	23	23	23			
		1000 V	--	--	--	--			
		400/380V 690/660V	7.5 13	7.5 13	9 15.5	9 15.5			
机械寿命 (x10 ⁶)		10		10		10		10	
电寿命 (x10 ⁶)		AC - 3	1.2	1.2	1.2	1.2			
		AC - 4	0.2	0.2	0.2	0.2			
操作频率 (1/h)		AC - 3	750	750	600	600			
		AC - 4	250	250	200	200			
吸引线圈工作电压范围 (AC)		(0.8~1.1)U _s							
线圈电压订货号		50Hz 线圈			60Hz 线圈			50/60Hz 线圈	
		50Hz	60Hz		60Hz	50Hz			
3TF3...-0X □□ 3TF4...-0X □□		24V	29V	B0	24V	20V	C1	24V	C2
		32V	38V	C0	110V	92V	G1	42V	D2
		36V	42V	G0	115V	96V	J1	110V	G2
		42V	50V	D0	120V	100V	K1	115V	J2
		48V	58V	H0	208V	173V	M1	120V	K2
		60V	72V	E0	220V	183V	N1	208V	M2
		110V	132V	F0	230V	192V	L1	220V	N2
		125/127V	150/152V	L0	240V	200V	P1	230V	L2
		220V	264V	M0	440V	367V	R1	240V	P2
		230V	277V	P0	575V	480V	S1	440V	R2
		240V	288V	U0				575V	S2
		380V	460V	Q0					
		400V	480V	V0					
		415V	500V	R0					
		500V	600V	S0					
吸引线圈功率消耗 (50Hz)		保持 (VA)	11	11	11	11			
		功率因数 p.f.	0.28	0.28	0.28	0.28			
		吸合 (VA)	101	101	101	101			
		功率因数 p.f.	0.83	0.83	0.83	0.83			
约定发热电流 (A)		55		55		55		55	
辅助触头约定发热电流 (A)		10		10		10		10	
辅助触头额定绝缘电压 (V)		690		690		690		690	
辅助触头额定工作电流 (A)		AC - 15 380/220V	4/6	4/6	4/6	4/6			
		DC - 13 110/220V	1.14/0.48	1.14/0.48	1.14/0.48	1.14/0.48			
重量 (kg)		0.68		0.8		0.68		0.8	

注：用于 3TF3 系列的 3TX4 辅助触头座见第 2/19 页

3TF交流接触器

选型与订货数据









交流操作										
辅助触头 NO 常开 NC 常闭										
订货号		3TF46 11 - 0X 3TF46 22 - 0X 3TF46 44 - 0X	1 1 2 2 4 4	3TF47 11 - 0X 3TF47 22 - 0X 3TF47 44 - 0X	1 1 2 2 4 4	3TF48 11 - 0X 3TF48 22 - 0X 3TF48 44 - 0X	1 1 2 2 4 4	3TF49 11 - 0X 3TF49 22 - 0X 3TF49 44 - 0X	1 1 2 2 4 4	
额定绝缘电压 (V)		1000		1000		1000		1000		
额定工作电流 (A) (380V)		AC - 3	45	63	75	85				
		AC - 4	24	28	34	42				
可控电机功率 (KW) 50Hz	AC - 3	230/220V	15	18.5	22	26				
		400/380V	22	30	37	45				
		500 V	30	41	50	59				
		690/660V	39	55	67	67				
		1000 V	-	-	39	39				
	AC - 4	400/380V	12.6/12	14.7/14	17.9/17	22/21				
		690/660V	21.8/20.8	25.4/24.3	30.9/29.5	38/36				
机械寿命 (x10 ⁶)		10		10		10		10		
电寿命 (x10 ⁶)		AC - 3	1.2	1.2	1.2	1.2				
		AC - 4	0.2	0.2	0.2	0.2				
操作频率 (1/h)		AC - 3	1200	1000	1000	850				
		AC - 4	400	300	300	250				
吸引线圈工作电压范围 (AC)		(0.8~1.1)U _e								
线圈电压订货号		50Hz 线圈			60Hz 线圈			50/60Hz 线圈		
		50Hz	60Hz		60Hz	50Hz		60Hz	50Hz	
3TF46...-0X □□ 3TF49...-0X □□		24V	29V	B0	24V	20V	C1	24V	C2	
		32V	38V	C0	110V	92V	G1	42V	D2	
		36V	42V	G0	115V	96V	J1	110V	G2	
		42V	50V	D0	120V	100V	K1	115V	J2	
		48V	58V	H0	208V	173V	M1	120V	K2	
		60V	72V	E0	220V	183V	N1	208V	M2	
		110V	132V	F0	230V	192V	L1	220V	N2	
		125/127V	150/152V	L0	240V	200V	P1	230V	L2	
		220V	264V	M0	440V	367V	R1	240V	P2	
		230V	277V	P0	575V	480V	S1	440V	R2	
		240V	288V	U0				575V	S2	
		380V	460V	Q0						
		400V	480V	V0						
		415V	500V	R0						
		500V	600V	S0						
吸引线圈功率消耗 (50Hz)		保持 (VA)	17	17	32	32				
		功率因数 p.f.	0.29	0.29	0.23	0.23				
		吸合 (VA)	183	183	330	330				
		功率因数 p.f.	0.6	0.6	0.5	0.5				
约定发热电流 (A)		80		90		100		100		
辅助触头约定发热电流 (A)		10		10		10		10		
辅助触头额定绝缘电压 (V)		690		690		690		690		
辅助触头额定工作电流 (A)		AC - 15 380/220V	4/6	4/6	4/6	4/6				
		DC - 13 110/220V	1.14/0.48	1.14/0.48	1.14/0.48	1.14/0.48				
重量 (kg)		1.4/1.6		1.4/1.6		2.3/2.5		2.3/2.5		

低压控制产品与系统

接触器和接触器组合







3TF交流接触器

选型与订货数据

交流操作										
辅助触头 NO 常开 NC 常闭										
订货号		3TF50 11 - 0X 3TF50 22 - 0X 3TF50 44 - 0X	1 1 2 2 4 4	3TF51 11 - 0X 3TF51 22 - 0X 3TF51 44 - 0X	1 1 2 2 4 4	3TF52 11 - 0X 3TF52 22 - 0X 3TF52 44 - 0X	1 1 2 2 4 4	3TF53 11 - 0X 3TF53 22 - 0X 3TF53 44 - 0X	1 1 2 2 4 4	
额定绝缘电压 (V)		1000		1000		1000		1000		
额定工作电流 (A)(380V)		AC - 3	110	140	170	205				
		AC - 4	54	68	75	96				
可控电机功率 (KW) 50Hz	AC - 3	230/220V	37	43	55	64				
		400/380V	55	75	90	110				
		500 V	76	98	118	145				
		690/660V	100	100	156	156				
AC - 4	1000 V	65	65	90	90					
	400/380V	28.4/27	36/35	40/38	52/50					
690/660V	49/46.9	63/60	69/66	90/86						
	机械寿命 (x10 ⁶)	10		10		10		10		
电寿命 (x10 ⁶)	AC - 3	1.2		1.2		1.2		1.2		
	AC - 4	0.2		0.2		0.2		0.2		
操作频率 (1/h)	AC - 3	1000		750		700		500		
	AC - 4	300		200		200		130		
吸引线圈工作电压范围 (AC)		(0.8~1.1)U _n								
线圈电压订货号		50Hz 线圈			60Hz 线圈			50/60Hz 线圈		
		50Hz	60Hz		60Hz	50Hz		24V	C2	
3TF50...0X □□ 3TF53...0X □□	24V	29V	B0	24V	20V	C1	24V	C2		
	32V	38V	C0	110V	92V	G1	42V	D2		
	36V	42V	G0	115V	96V	J1	110V	G2		
	42V	50V	D0	120V	100V	K1	115V	J2		
	48V	58V	H0	208V	173V	M1	120V	K2		
	60V	72V	E0	220V	183V	N1	208V	M2		
	110V	132V	F0	230V	192V	L1	220V	N2		
	125/127V	150/152V	L0	240V	200V	P1	230V	L2		
	220V	264V	M0	440V	367V	R1	240V	P2		
	230V	277V	P0	575V	480V	S1	440V	R2		
	240V	288V	U0				575V	S2		
	380V	460V	Q0							
	400V	480V	V0							
	415V	500V	R0							
500V	600V	S0								
吸引线圈功率消耗 (50Hz)	保持 (VA)	39		39		58		58		
	功率因数 p.f.	0.24		0.24		0.26		0.26		
	吸合 (VA)	550		550		910		910		
	功率因数 p.f.	0.45		0.45		0.38		0.38		
约定发热电流 (A)		160		160		210		220		
辅助触头约定发热电流 (A)		10		10		10		10		
辅助触头额定绝缘电压 (V)		690		690		690		690		
辅助触头额定工作电流 (A)	AC - 15 380/220V	4/6		4/6		4/6		4/6		
	DC - 13 110/220V	1.14/0.48		1.14/0.48		1.14/0.48		1.14/0.48		
重量 (kg)		3.3/3.5		3.3/3.5		4.8/5.0		4.8/5.0		

3TF交流接触器

选型与订货数据









交流操作									
辅助触头 NO 常开 NC 常闭									
订货号		3TF54 11 - 0X 3TF54 22 - 0X 3TF54 44 - 0X	1 1 2 2 4 4	3TF55 11 - 0X 3TF55 22 - 0X 3TF55 44 - 0X	1 1 2 2 4 4	3TF56 11 - 0X 3TF56 22 - 0X 3TF56 44 - 0X	1 1 2 2 4 4		
额定绝缘电压 (V)		1000		1000		1000			
额定工作电流 (A) (380V)		AC - 3 AC - 4	250 110	300 125	400 150				
可控电机功率 (KW) 50Hz	AC - 3	230/220V	78	93	125				
		400/380V	132	160	200				
		500 V	178	210	284				
		690/660V	235	235	375				
AC - 4	1000 V	132	132	250					
	400/380V 690/660V	61/58 105/100	69/66 119/114	85/81 147/140					
机械寿命 (x10 ⁶)		10		10		10			
电寿命 (x10 ⁶)		AC - 3 AC - 4	1.2 0.2	1.2 0.2	1.2 0.2				
操作频率 (1/h)		AC - 3 AC - 4	700 200	500 130	500 150				
吸引线圈工作电压范围 (AC)		(0.8~1.1)U _n							
线圈电压订货号		50Hz 线圈		60Hz 线圈			50/60Hz 线圈		
3TF54---0X □□		50Hz	60Hz	50Hz	60Hz	50/60Hz			
3TF56---0X □□		24V	29V	B0	24V	20V	C1	24V	C2
		32V	38V	C0	110V	92V	G1	42V	D2
		36V	42V	G0	115V	96V	J1	110V	G2
		42V	50V	D0	120V	100V	K1	115V	J2
		48V	58V	H0	208V	173V	M1	120V	K2
		60V	72V	E0	220V	183V	N1	208V	M2
		110V	132V	F0	230V	192V	L1	220V	N2
		125/127V	150/152V	L0	240V	200V	P1	230V	L2
		220V	264V	M0	440V	367V	R1	240V	P2
		230V	277V	P0	575V	480V	S1	440V	R2
		240V	288V	U0				575V	S2
		380V	460V	Q0					
		400V	480V	V0					
		415V	500V	R0					
		500V	600V	S0					
吸引线圈功率消耗 (50Hz)		保持 (VA)	84		84			115	
		功率因数 p.f.	0.24		0.24			0.33	
		吸合 (VA)	1430		1430			2450	
		功率因数 p.f.	0.34		0.34			0.21	
约定发热电流 (A)		300		300			400		
辅助触头约定发热电流 (A)		10		10			10		
辅助触头额定绝缘电压 (V)		690		690			690		
辅助触头额定工作电流 (A)		AC - 15 380/220V DC - 13 110/220V	4/6		4/6			4/6	
重 量 (kg)		6.2/6.4		6.2/6.4			8.5/8.7		

低压控制产品与系统

接触器和接触器组合

3TF直流控制









选型与订货数据

直流操作					
辅助触头 NO 常开 NC 常闭					
订货号		3TF30 00 - 1X 3TF30 10 - 1X 3TF30 01 - 1X	3TF40 10 - 1X 3TF40 01 - 1X 3TF40 11 - 1X 3TF40 20 - 1X 3TF40 22 - 1X 3TF40 31 - 1X	3TF31 00 - 1X 3TF31 10 - 1X 3TF31 01 - 1X	3TF41 10 - 1X 3TF41 01 - 1X 3TF41 11 - 1X 3TF41 20 - 1X 3TF41 22 - 1X 3TF41 31 - 1X
额定绝缘电压 (V)		690	690	690	690
额定工作电流 (A) (380V)	AC - 3	9	9	12	12
	AC - 4	3.3	3.3	4.3	4.3
可控电机功率 (KW) 50Hz	AC - 3	230/220V 400/380V 500 V 690/660V 1000 V	2.4 4 5.5 5.5 --	2.4 4 5.5 5.5 --	3.3 5.5 7.5 7.5 --
	AC - 4	400/380V 690/660V	1.48/1.4 2.54/2.4	1.48/1.4 2.54/2.4	2/1.9 3.45/3.3
机械寿命 (x10 ⁶)		15	15	15	15
电寿命 (x10 ⁶)	AC - 3	1.2	1.2	1.2	1.2
	AC - 4	0.2	0.2	0.2	0.2
操作频率 (1/h)	AC - 3	1000	1000	1000	1000
	AC - 4	250	250	250	250
吸引线圈工作电压范围 (AC)		(0.8~1.1)U _s			
线圈电压订货号	额定 控制电压	V DC 12 21.5 24 30 36 42 48 60 110 125 180 220 230 240 250			
	订货号	A4 U4 B4 C4 V4 D4 W4 E4 F4 G4 K4 M4 P4 Q4 N4			
吸引线圈功率消耗	吸合和保持 (W)	6.2	6.2	6.2	6.2
约定发热电流 (A)		20	20	20	20
辅助触头约定发热电流 (A)		10	10	10	10
辅助触头额定绝缘电压 (V)		690	690	690	690
辅助触头额定工作电流 (A)	AC - 15 380/220V	6/10	6/10	6/10	6/10
	DC - 13 110/220V	0.9/0.45	0.9/0.45	0.9/0.45	0.9/0.45
重量 (kg)		0.58	0.64	0.58	0.64

注：用于 3TF3 系列的 3TX4 辅助触头座见第 2/19 页

3TF直流控制

选型与订货数据

直流操作																			
辅助触头 NO 常开 NC 常闭																			
订货号		3TF32 00 - 1X 3TF32 11 - 1X	- - 1 1	3TF42 10 - 1X 3TF42 11 - 1X 3TF42 20 - 1X 3TF42 22 - 1X	1 - 1 1 2 - 2 2	3TF33 00 - 1X 3TF33 11 - 1X	- - 1 1	3TF43 10 - 1X 3TF43 11 - 1X 3TF43 20 - 1X 3TF43 22 - 1X	1 - 1 1 2 - 2 2										
额定绝缘电压 (V)		690		690															
额定工作电流 (A) (380V)		AC - 3	16	16	22	22													
		AC - 4	7.7	7.7	8.5	8.5													
可控电机功率 (KW) 50Hz	AC - 3	230/220V	4	4	5.5	5.5													
		400/380V	7.5	7.5	11	11													
500 V		9	9	11	11														
690/660V		11	11	11	11														
1000 V		--	--	--	--														
AC - 4	400/380V	3.5	3.5	4	4														
	690/660V	6	6	6.6	6.6														
机械寿命 (x10 ⁶)		15		15															
电寿命 (x10 ⁶)		AC - 3	1.2	1.2	1.2	1.2													
		AC - 4	0.2	0.2	0.2	0.2													
操作频率 (1/h)		AC - 3	750	750	750	750													
		AC - 4	250	250	250	250													
吸引线圈工作电压范围 (AC)		(0.8~1.1)U _s																	
线圈电压订货号		<table border="1"> <tr> <td>额定控制电压</td> <td>V DC</td> <td>24</td> <td>48</td> <td>110</td> <td>125</td> <td>220</td> </tr> <tr> <td>订货号</td> <td></td> <td>B4</td> <td>W4</td> <td>F4</td> <td>G4</td> <td>M4</td> </tr> </table>				额定控制电压	V DC	24	48	110	125	220	订货号		B4	W4	F4	G4	M4
额定控制电压	V DC	24	48	110	125	220													
订货号		B4	W4	F4	G4	M4													
3TF3...-1X □□ 3TF4...-1X □□																			
吸引线圈功率消耗	吸合和保持 (W)	6.2	6.2	6.2	6.2														
约定发热电流 (A)		30		30															
辅助触头约定发热电流 (A)		10		10															
辅助触头额定绝缘电压 (V)		690		690															
辅助触头额定工作电流 (A)		AC - 15 380/220V	4/6	6/10	4/6	6/10													
		DC - 13 110/220V	1.14/0.48	0.9/0.45	1.14/0.48	0.9/0.45													
重量 (kg)		0.70		0.66															









注：用于 3TF3 系列的 3TX4 辅助触头座见第 2/19 页

低压控制产品与系统

接触器和接触器组合

3TF直流控制









选型与订货数据

直流操作																											
辅助触头 NO 常开 NC 常闭																											
订货号		3TF34 00 - 1X 3TF34 11 - 1X	- - 1 1	3TF44 11 - 1X 3TF44 22 - 1X	1 1 2 2	3TF35 00 - 1X 3TF35 11 - 1X	- - 1 1	3TF45 11 - 1X 3TF45 22 - 1X	1 1 2 2																		
额定绝缘电压 (V)		690		690		690		690																			
额定工作电流 (A) (380V)		AC - 3	32	32	38	38																					
		AC - 4	15.6	15.6	18.5	18.5																					
可控电机功率 (KW) 50Hz	AC - 3	230/220V	8.5	8.5	11	11																					
		400/380V	15	15	18.5	18.5																					
	500 V	21	21	25	25																						
	690/660V	23	23	23	23																						
AC - 4	1000 V	--	--	--	--																						
	400/380V	7.5	7.5	9	9																						
	690/660V	13	13	15.5	15.5																						
机械寿命 (x10 ⁶)		10		10		10		10																			
电寿命 (x10 ⁶)		AC - 3	1.2	1.2	1.2	1.2																					
		AC - 4	0.2	0.2	0.2	0.2																					
操作频率 (1/h)		AC - 3	750	750	600	600																					
		AC - 4	250	250	200	200																					
吸引线圈工作电压范围 (AC)		(0.8~1.1)U _s																									
线圈电压订货号		<table border="1"> <tr> <td>额定控制电压</td> <td>V DC</td> <td>24</td> <td>48</td> <td>110</td> <td>125</td> <td>220</td> <td colspan="2"></td> </tr> <tr> <td>订货号</td> <td></td> <td>B4</td> <td>W4</td> <td>F4</td> <td>G4</td> <td>M4</td> <td colspan="2"></td> </tr> </table>								额定控制电压	V DC	24	48	110	125	220			订货号		B4	W4	F4	G4	M4		
额定控制电压	V DC	24	48	110	125	220																					
订货号		B4	W4	F4	G4	M4																					
3TF3...1X □□ 3TF4...1X □□																											
吸引线圈功率消耗	吸合和保持 (W)	11.7	11.7	11.7	11.7																						
约定发热电流 (A)		55		55		55		55																			
辅助触头约定发热电流 (A)		10		10		10		10																			
辅助触头额定绝缘电压 (V)		690		690		690		690																			
辅助触头额定工作电流 (A)		AC - 15 380/220V	4/6	4/6	4/6	4/6																					
		DC - 13 110/220V	1.14/0.48	1.14/0.48	1.14/0.48	1.14/0.48																					
重量 (kg)		1.25	1.43	1.25	1.43																						

注：用于 3TF3 系列的 3TX4 辅助触头座见第 2/19 页

3TF直流控制

选型与订货数据





直流操作																											
辅助触头 NO 常开 NC 常闭																											
订货号		3TF46 22 - 1X 3TF46 33 - 1X	2 2 3 3	3TF47 22 - 1X 3TF47 33 - 1X	2 2 3 3	3TF48 22 - 1X 3TF48 33 - 1X	2 2 3 3	3TF49 22 - 1X 3TF49 33 - 1X	2 2 3 3																		
额定绝缘电压 (V)		1000		1000		1000		1000																			
额定工作电流 (A) (380V)		AC - 3	45	63	75	85																					
		AC - 4	24	28	34	42																					
可控电机功率 (KW) 50Hz	AC - 3	230/220V 400/380V 500 V 690/660V 1000 V	15 22 30 39 7-5	18.5 30 41 55 7-5	22 37 50 67 39	26 45 59 67 39																					
	AC - 4	400/380V 690/660V	12.6/12 21.8/20.8	14.7/14 25.4/24.3	17.9/17 30.9/29.5	22/21 38/36																					
机械寿命 (x10 ⁶)		3		3		3		3																			
电寿命 (x10 ⁶)		AC - 3	1.2	1.2	1.2	1.2																					
		AC - 4	0.2	0.2	0.2	0.2																					
操作频率 (1/h)		AC - 3	1200	1000	1000	850																					
		AC - 4	400	300	300	250																					
吸引线圈工作电压范围 (AC)		(0.8~1.1)U _s																									
线圈电压订货号		<table border="1"> <thead> <tr> <th>额定控制电压</th> <th colspan="5">V DC</th> </tr> </thead> <tbody> <tr> <td>24</td> <td>48</td> <td>110</td> <td>125</td> <td>220</td> <td></td> </tr> <tr> <td>订货号</td> <td>B4</td> <td>W4</td> <td>F4</td> <td>G4</td> <td>M4</td> </tr> </tbody> </table>								额定控制电压	V DC					24	48	110	125	220		订货号	B4	W4	F4	G4	M4
额定控制电压	V DC																										
24	48	110	125	220																							
订货号	B4	W4	F4	G4	M4																						
3TF46...1X □□																											
3TF49...1X □□																											
吸引线圈功率消耗		保持 (W)	2.1	2.1	2.7	2.7																					
		吸合 (W)	400	400	420	420																					
约定发热电流 (A)		80		90		100		100																			
辅助触头约定发热电流 (A)		10		10		10		10																			
辅助触头额定绝缘电压 (V)		690		690		690		690																			
辅助触头额定工作电流 (A)		AC - 15 380/220V	4/6		4/6		4/6		4/6																		
		DC - 13 110/220V	1.14/0.48		1.14/0.48		1.14/0.48		1.14/0.48																		
重量 (kg)		1.4/1.6		1.4/1.6		2.3/2.5		2.3/2.5																			

低压控制产品与系统

接触器和接触器组合

3TF直流控制



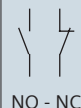
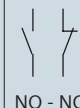
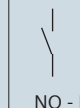



选型与订货数据

直流操作																											
辅助触头 NO 常开 NC 常闭																											
订货号		3TF50 22 - 1X 3TF50 33 - 1X	2 2 3 3	3TF51 22 - 1X 3TF51 33 - 1X	2 2 3 3	3TF52 22 - 1X 3TF52 33 - 1X	2 2 3 3	3TF53 22 - 1X 3TF53 33 - 1X	2 2 3 3																		
额定绝缘电压 (V)		1000		1000		1000		1000																			
额定工作电流 (A) (380V)		AC - 3	110	140	170	205																					
		AC - 4	54	68	75	96																					
可控电机功率 (KW) 50Hz	AC - 3	230/220V	37	43	55	64																					
		400/380V	55	75	90	110																					
		500 V	76	98	118	145																					
		690/660V	100	100	156	156																					
		1000 V	65	65	90	90																					
		AC - 4	28.4/27 49/46.9	36/35 63/60	40/38 69/66	52/50 90/86																					
机械寿命 (x10 ⁶)		3		3		3		3																			
电寿命 (x10 ⁶)		AC - 3	1.2	1.2	1.2	1.2																					
		AC - 4	0.2	0.2	0.2	0.2																					
操作频率 (1/h)		AC - 3	1000	750	700	500																					
		AC - 4	300	200	200	130																					
吸引线圈工作电压范围 (AC)		(0.8~1.1)U _e																									
线圈电压订货号		<table border="1"> <tr> <td>额定控制电压</td> <td>V DC</td> <td>24</td> <td>48</td> <td>110</td> <td>125</td> <td>220</td> <td colspan="2"></td> </tr> <tr> <td>订货号</td> <td></td> <td>B4</td> <td>W4</td> <td>F4</td> <td>G4</td> <td>M4</td> <td colspan="2"></td> </tr> </table>								额定控制电压	V DC	24	48	110	125	220			订货号		B4	W4	F4	G4	M4		
额定控制电压	V DC	24	48	110	125	220																					
订货号		B4	W4	F4	G4	M4																					
3TF50...-1X □□																											
3TF53...-1X □□																											
吸引线圈功率消耗		保持 (W)	2.7	2.7	11	11																					
		吸合 (W)	500	500	876	876																					
约定发热电流 (A)		160		160		210		220																			
辅助触头约定发热电流 (A)		10		10		10		10																			
辅助触头额定绝缘电压 (V)		690		690		690		690																			
辅助触头额定工作电流 (A)		AC - 15 380/220V	4/6	4/6	4/6	4/6																					
		DC - 13 110/220V	1.14/0.48	1.14/0.48	1.14/0.48	1.14/0.48																					
重量 (kg)		3.3/3.5		3.3/3.5		5.4/5.6		5.4/5.6																			

注: 3TF52 ~ 3TF56 直流操作接触器所必需的切换接触器包含在接触器包装中一起发货。

3TF直流控制

选型与订货数据

直流操作																		
辅助触头 NO 常开 NC 常闭																		
订货号		3TF54 22 - 1X 3TF54 33 - 1X	3TF55 22 - 1X 3TF55 33 - 1X	3TF56 22 - 1X 3TF56 33 - 1X														
额定绝缘电压 (V)		1000	1000	1000														
额定工作电流 (A) (380V)	AC - 3	250	300	400														
	AC - 4	110	125	150														
可控电机功率 (KW) 50Hz	AC - 3	230/220V 400/380V 500 V 690/660V 1000 V	78 132 178 235 132	93 160 210 235 132														
	AC - 4	400/380V 690/660V	61/58 105/100	69/66 119/114														
机械寿命 (x10 ⁶)		3	3	3														
电寿命 (x10 ⁶)	AC - 3	1.2	1.2	1.2														
	AC - 4	0.2	0.2	0.2														
操作频率 (1/h)	AC - 3	700	500	500														
	AC - 4	200	130	150														
吸引线圈工作电压范围 (AC)		(0.8~1.1)U _s																
线圈电压订货号		<table border="1"> <tr> <td>额定控制电压</td> <td>V DC</td> <td>24</td> <td>48</td> <td>110</td> <td>125</td> <td>220</td> </tr> <tr> <td>订货号</td> <td></td> <td>B4</td> <td>W4</td> <td>F4</td> <td>G4</td> <td>M4</td> </tr> </table>			额定控制电压	V DC	24	48	110	125	220	订货号		B4	W4	F4	G4	M4
额定控制电压	V DC	24	48	110	125	220												
订货号		B4	W4	F4	G4	M4												
吸引线圈功率消耗	保持 (W)	13.3	13.3	14														
	吸合 (W)	1216	1216	1306														
约定发热电流 (A)		300	300	400														
辅助触头约定发热电流 (A)		10	10	10														
辅助触头额定绝缘电压 (V)		690	690	690														
辅助触头额定工作电流 (A)	AC - 15 380/220V	4/6	4/6	4/6														
	DC - 13 110/220V	1.14/0.48	1.14/0.48	1.14/0.48														
重量 (kg)		6.8/7.0	6.8/7.0	9.2/9.4														











注：3TF52 ~ 3TF56 直流操作接触器所必需的切换接触器包含在接触器包装中一起发货。

低压控制产品与系统

接触器和接触器组合

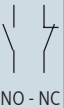

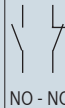

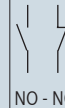
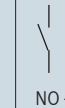







3TS交流接触器

选型与订货数据

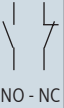
交流操作								
辅助触头 NO 常开 NC 常闭								
订货号	交流控制	3TS29 00-0X - - 3TS29 01-0X - 1 3TS29 10-0X 1 -	3TS30 00-0X - - 3TS30 01-0X - 1 3TS30 10-0X 1 -	3TS31 00-0X - - 3TS31 01-0X - 1 3TS31 10-0X 1 -	3TS32 00-0X - - 3TS32 01-0X - 1 3TS32 10-0X 1 -	3TS33 00-0X - - 3TS33 11-0X 1 1	3TS34 00-0X - - 3TS34 11-0X 1 1	
	直流控制	3TS29 00-1X - - 3TS29 01-1X - 1 3TS29 10-1X 1 -	3TS30 00-1X - - 3TS30 01-1X - 1 3TS30 10-1X 1 -	3TS31 00-1X - - 3TS31 01-1X - 1 3TS31 10-1X 1 -	3TS32 00-1X - - 3TS32 01-1X - 1 3TS32 10-1X 1 -	3TS33 00-1X - - 3TS33 11-1X 1 1	3TS34 00-1X - - 3TS34 11-1X 1 1	
额定绝缘电压 (V)		660	660	660	660	660	660	
额定工作电流 (A) (380V)		AC - 3	6	9	12	18	25	32
		AC - 4	3.1	3.3	4.3	7.7	8.5	15.6
可控电机功率 (KW)	AC - 3 230/220V 400/380V	1.5 2.2	2.4 4	3.3 5.5	4 7.5	5.5 11	8.5 15	
	AC - 4 400/380V	1.15	1.4	1.9	3.5	4	7.5	
机械寿命 (x10 ⁶)		10	10	10	10	10	10	
电寿命 (x10 ⁶)		AC - 3	1.0	1.0	1.0	1.0	1.0	
		AC - 4	0.2	0.2	0.2	0.2	0.2	
操作频率 (1/h)		AC - 3	1000	1000	1000	750	750	750
		AC - 4	250	250	250	250	250	250
吸引线圈工作电压范围 (AC)		(0.8~1.1)U _s						
线圈电压订货号		50Hz 线圈						
AC 3TS29...-0X □□ ? 3TS34...-0X □□		V AC						
		24			B0			
		110			F0			
		220			M0			
DC 3TS29...-1X □□ ? 3TS34...-1X □□		V DC						
		214			B4			
吸引线圈功率消耗 (50Hz)	保持 (VA)	7.8	7.8	7.8	7.8	7.8	7.8	
	功率因数 p.f.	0.29	0.29	0.29	0.29	0.29	0.29	
	吸合 (VA)	68	68	68	68	68	69	
	功率因数 p.f.	0.82	0.82	0.82	0.82	0.82	0.86	
直流吸引线圈功率消耗吸合和保持 (W)		6.2	6.2	6.2	6.2	6.2	6.2	
约定发热电流 (A) I _{th}		25	25	25	25	42	42	
辅助触头约定发热电流 (A)		10	10	10	10	10	10	
辅助触头额定绝缘电压 (V)		660	660	660	660	660	660	
辅助触头额定工作电流 (A)		AC - 15 380/220V	6/10	6/10	6/10	6/10	4/6	4/6
		DC - 13 110/220V	0.9/0.45	0.9/0.45	0.9/0.45	0.9/0.45	0.8/0.2	0.8/0.2
重量 (kg)		AC 操作	0.37	0.37	0.37	0.37	0.45	0.45
		DC 操作	0.58	0.58	0.58	0.58	0.70	0.70

3TS交流接触器

选型与订货数据







交流操作								
辅助触头 NO 常开 NC 常闭								
订货号	交流控制	3TS35 00-0X - - 3TS35 11-0X 1 1	3TS36 00-0X - - 3TS36 11-0X 1 1	3TS47 11-0X 1 1 3TS47 22-0X 2 2 3TS47 44-0X 4 4	3TS48 11-0X 1 1 3TS48 22-0X 2 2 3TS48 44-0X 4 4	3TS49 11-0X 1 1 3TS49 22-0X 2 2 3TS49 44-0X 4 4	3TS50 11-0X 1 1 3TS50 22-0X 2 2 3TS50 44-0X 4 4	
	直流控制	3TS35 00-1X - - 3TS35 11-1X 1 1	3TS36 00-1X - - 3TS36 11-1X 1 1	3TS47 11-1X 1 1 3TS47 22-1X 2 2 3TS47 33-1X 3 3	3TS48 11-1X 1 1 3TS48 22-1X 2 2 3TS48 33-1X 3 3	3TS49 11-1X 1 1 3TS49 22-1X 2 2 3TS49 33-1X 3 3	3TS50 11-1X 1 1 3TS50 22-1X 2 2 3TS50 33-1X 3 3	
额定绝缘电压 (V)		690	690	1000	1000	1000	1000	
额定工作电流 (A) (380V)		AC - 3	40	45	65	75	85	105
		AC - 4	18.5	24	28	34	42	54
可控电机功率 (KW)	AC - 3 230/220V 400/380V	11 18.5	15 22	18.5 30	22 37	26 45	37 55	
	AC - 4 400/380V	9	12.6/12	14.7/14	17.9/17	22/21	28.4/27	
机械寿命 (x10 ⁶)		10	10	10	10	10	10	
电寿命 (x10 ⁶)		AC - 3	1.0	1.0	1.0	1.0	1.0	
		AC - 4	0.2	0.2	0.2	0.2	0.2	0.2
操作频率 (1/h)		AC - 3	600	600	750	750	750	
		AC - 4	200	200	300	300	250	300
吸引线圈工作电压范围 (AC)		(0.8~1.1)U _N						
线圈电压订货号		50Hz 线圈						
AC	3TS35...-0X □□ 3TS50...-0X □□	V AC		B0				
		24		F0				
		110		M0				
		220		Q0				
DC	3TS35...-1X □□ 3TS50...-1X □□	V DC		B4				
		24						
吸引线圈功率消耗 (AC)	保持 (VA)	11	11	17	17	32	32	
	功率因数 p.f.	0.28	0.28	0.29	0.29	0.23	0.23	
	吸合 (VA)	101	101	183	183	330	330	
	功率因数 p.f.	0.83	0.83	0.6	0.6	0.5	0.5	
吸引线圈功率消耗 (DC)	保持 (W)	11.7	11.7	2.1	2.1	2.7	2.7	
	吸合 (W)	11.7	11.7	400	400	420	420	
约定发热电流 (A) I _{th}		65	85	90	95	105	105	
辅助触头约定发热电流 (A)		10	10	10	10	10	10	
辅助触头额定绝缘电压 (V)		660	660	660	660	660	660	
辅助触头额定工作电流 (A)		AC - 15 380/220V	4/6	4/6	4/6	4/6	4/6	
		DC - 13 110/220V	0.8/0.2	0.8/0.2	1.14/0.8	1.14/0.8	1.14/0.8	1.14/0.8
重量 (kg)	AC 操作	0.68	0.68	1.4/1.6	1.4/1.6	2.3/2.5	2.3/2.5	
	DC 操作	1.25	1.25	1.4/1.6	1.4/1.6	2.3/2.5	2.3/2.5	

低压控制产品与系统

接触器和接触器组合

3TB交流接触器

选型与订货数据

交流操作															
订货号 NO 常开 NC 常闭		NO - NC		NO - NC		NO - NC		NO - NC		NO - NC					
订货号		3TB39 10 - 0X 3TB39 01 - 0X 3TB39 22 - 0X	1 - - 1 2 2	3TB40 10 - 0X 3TB40 01 - 0X 3TB40 22 - 0X	1 - - 1 2 2	3TB41 10 - 0X 3TB41 01 - 0X 3TB41 22 - 0X	1 - - 1 2 2	3TB42 11 - 0X 3TB42 22 - 0X	1 1 2 2	3TB43 11 - 0X 3TB43 22 - 0X	1 1 2 2	3TB44 22 - 0X	2 2		
额定绝缘电压 (V)		660		660		660		660		660					
额定工作电流 (A) (380V)		AC - 3		6		9		12		16		22		32	
		AC - 4		3.1		3.3		4.3		7.7		8.5		15.6	
可控电机功率 (KW)	AC - 3		230/220V 400/380V 500 V 660 V	1.5 2.2 3 4	2.4 4 5.5 5.5	3.3 5.5 7.5 7.5	4 7.5 10 11	6.1 11 11 11	8.5 15 21 23						
	AC - 4		400/380V 660 V	1.15 1.9	1.4 2.4	1.9 3.3	3.5 6	4 6.6	7.5 13						
机械寿命 (x10 ⁶)		10		10		10		10		10					
电寿命 (x10 ⁶)		AC - 3		1.0		1.0		1.0		1.0					
		AC - 4		0.2		0.2		0.2		0.2					
操作频率 (1/h)		AC - 3		1000		1000		750		750					
		AC - 4		250		250		250		250					
吸引线圈工作电压范围 (AC)		(0.8~1.1)U _N													
线圈电压订货号		50Hz 线圈					50/60Hz 线圈								
3TB39...-0X □□		V AC					V AC								
3TB44...-0X □□		24 42 110 220 240 380					B0 D0 F0 M0 U0 Q0								
吸引线圈功率消耗 (50Hz)		保持 (VA)		7.8		7.8		7.8		7.8		10			
		功率因数 p.f.		0.29		0.29		0.29		0.29		0.29			
		吸合 (VA)		68		68		68		68		69			
		功率因数 p.f.		0.82		0.82		0.82		0.82		0.86			
约定发热电流 (A) I _{th}		20		20		20		30		30		45			
辅助触头约定发热电流 (A)		10		10		10		10		10		10			
辅助触头额定绝缘电压 (V)		660		660		660		660		660		660			
辅助触头额定工作电流 (A)		AC - 15 380/220V		6/10		6/10		6/10		6/10		4/6			
		DC - 13 110/220V		0.9/0.45		0.9/0.45		0.9/0.45		0.9/0.45		1.14/0.48			
重量 (kg)		0.43		0.43		0.43		0.49		0.49		0.7			

3TF交流接触器

3TF/3TS备件

型号	所配接触器型号	触头型式		订货号	说明	重量 kg
		NO	NC			
 3TY75 61-1. 辅助触头组	3TF32 00, 3TF33 00	1	1	3TX4 011 - 8A	左侧辅助触头	0.042
	3TF34 00, 3TF35 00	1	1	3TY7 561 - 1AA00	左侧辅助触头	
	3TF44 - 3TF56 (不带侧面辅助触头)	1	1	3TY7 561 - 1AA00	左侧辅助触头	
		1	1	3TY7 561 - 1AA00	右侧辅助触头	
	3TF46 - 3TF56 (带一组侧面辅助触头)	1	1	3TY7 561 - 1KA00	左侧第二组辅助触头组	
		1	1	3TY7 561 - 1KA00	右侧第二组辅助触头组	
	3TS35 00, 3TS36 00	1	1	3TY7 601 - 1AA00	左侧辅助触头	
	3TS47 - 3TS50 (不带侧面辅助触头)	1	1	3TY7 601 - 1AA00	左侧辅助触头	
		1	1	3TY7 601 - 1AA00	右侧辅助触头	
 线圈	3TF30 - 3TF33 3TF40 - 3TF43 3TH3 - 3TH4			3TY7 403 - 0X..	双线圈从 3TF48 开始	0.07
	3TF34 - 3TF35 3TF44 - 3TF45			3TY7 443 - 0X..		0.1
	3TF46, 3TF47			3TY7 463 - 0X..		0.12
	3TF48, 3TF49 3TF50, 3TF51 3TF52, 3TF53 3TF54, 3TF55 3TF56			3TY7 483 - 0X.. 3TY7 503 - 0X.. 3TY7 523 - 0X.. 3TY7 543 - 0X.. 3TY7 563 - 0X..		0.2 0.23 0.35 0.39 0.56
 3TY7..0 - 0X 触桥 触头	3TF44 3TF45			3TY74 40 - 0X 3TY74 50 - 0X	3 件触桥和 6 件触头为 1 套	0.1
	3TF46 3TF47			3TY74 60 - 0X 3TY74 70 - 0X		0.1
	3TF48 3TF49			3TY74 80 - 0X 3TY74 90 - 0X		0.13
	3TF50 3TF51			3TY75 00 - 0X 3TY75 10 - 0X		0.25
	3TF52 3TF53			3TY75 20 - 0X 3TY75 30 - 0X		0.3
	3TF54 3TF55			3TY75 40 - 0X 3TY75 50 - 0X		0.47
	3TF56			3TY75 60 - 0X		0.73
 3TY7..2 - 0X 灭弧室	3TF44 3TF45			3TY74 42 - 0X 3TY74 52 - 0X	灭弧室	0.15
	3TF46 3TF47			3TY74 62 - 0X 3TY74 72 - 0X		0.28
	3TF48 3TF49			3TY74 82 - 0X 3TY74 92 - 0X		0.45
	3TF50 3TF51			3TY75 02 - 0X 3TY75 12 - 0X		0.75
	3TF52 3TF53			3TY75 22 - 0X 3TY75 32 - 0X		1
	3TF54 3TF55			3TY75 42 - 0X 3TY75 52 - 0X		1.3
	3TF56			3TY75 62 - 0X		1.7

低压控制产品与系统

接触器和接触器组合

3TF/3TS交流接触器

辅助触头座

当需要外加辅助触头时，可选用 3TX4 型辅助触头座。（请注意：接触器中只有 3TF3 系列可以加装 3TX4）。
3TF3 系列接触器上最多可同时插装 4 个 INO 或 INC 的 3TX4 型辅助触头座。

安装尺寸见 3TH30 安装尺寸图。

 3TX4	额定工作电流 I_e /AC - 15/AC - 14				触头		订货号	重量 kg
	230/ 220V A	400/ 380V A	500V A	690/ 660V A	NO	NC		
	5.6/6	3.8/4	2.5	1.8/2	1	-	3TX4 010 - 2A 3TX4 001 - 2A 3TX4 010 - 3A*	0.02

* 3TX4010 - 3A 带开关位置指示

3TS 系列接触器上最多可同时插装 4 个 1NO 或 1NC 的 3TX3 型辅助触头座。

注：对 3TS29~3201，可同时插装 4NO 或 3NO1NC 或 2NO2NC。

对 3TS33~3611，可同时插装 3NO 或 2NC 或 2NO1NC。

 3TX3	5.6/6	3.8/4	2.5	1.8/2	触头		订货号	重量 kg
					1	-		
					-	1	3TX3 010 - 2A 3TX3 001 - 2A	0.02

3TF/3TS接触器附件

选型与订货数据



 3TX4091-1A	机械连锁模块 用于两个接触器的机械互锁				
	相同尺寸	接触器组合模块	2 个接触器型号	订货号	重量 kg
	0 to 2	自行组装	3TF30 to 3TF35 3TS29 to 3TS36 3TF44 to 3TF55 3TF56	3TX4091-1A*	0.02
2 to 10 12	3TD44 02 to 3TD54 02 3TD56 02		3TX7466-1XA1 3TX7566-1XA1	0.13 0.13	
对不同尺寸					
2 to 10 12 与 8, 10	3TD44 02 to 3TD54 02 自行组装		3TX7466-1XA1 3TX7566-1XB1	0.13 0.13	

注：* 正面互锁，两个接触器中间不可有侧挂辅助触头。

	接触器型号	规格	额定控制电压	订货号	重量 kg
 3TX7462-3D	浪涌抑制器 二极管				
	3TF30 to 3TF35, 3TF40 to 3TF45, 3TC44 ⁴⁾	抑制二极管 线插接式，连接安装于线圈端子 二极管组合	24 to 250 V DC	3TX7402-3A	0.01
	3TF30 to 3TF35, 3TF40 to 3TF45, 3TC44 ⁴⁾	(二极管和稳压二极管) 用于直流操作和短断 开时期，线插接式，连接安装于线圈端子	24 to 250 V DC	3TX7402-3D	0.01
	3TF46, 3TF47 ²⁾ 3TB52 to 3TB56 3TC48 to 3TC56	二极管组合 (二极管和稳压二极管) 用于直流操作和短断 开时期，线插接式，连接安装于线圈端子	24 to 250 V DC	3TX7462-3D	0.01

3TF接触器附件

选型与订货数据

	接触器型号	规格	额定控制电压	订货号	重量 kg
 <p>3TX4490-0V., 3TX4490-0W</p>  <p>3TX7462-3</p>  <p>3TX7462-3 3TX7522-3 (RC) 3TX7572-3 (压敏电阻)</p>	浪涌抑制器 压敏电阻式				
	3TF30 to 3TF33, 3TF40 to 3TF43	压敏电阻式 针对支流和交流操作, 卡 装于 35 毫米标准安装导轨	24 to 48 V AC 24 to 70 V DC 127 to 240 V AC 150 to 250 V DC	3TX4490-0V 3TX4490-0W	0.02 0.075
	3TF30 to 3TF35, 3TF40 to 3TF45, 3TC44 ⁵⁾	压敏电阻式 线插接式, 连接安装于线 圈端子	24 to 48 V AC, 24 to 70 V DC 48 to 127 V AC, 70 to 150 V DC 127 to 240 V AC, 150 to 250 V DC 240 to 400 V AC 400 to 600 V DC	3TX7402-3G 3TX7402-3H 3TX7402-3J 3TX7402-3K 3TX7402-3L	0.015
	TF46 to 3TF56 ³⁾ , 3TB48 and 3TB50, 3TC48	压敏电阻式 植入接触器底座或独立安 装	24 to 48 V AC, 24 to 70 V DC 48 to 127 V AC, 70 to 150 V DC 127 to 240 V AC, 150 to 250 V DC 240 to 400 V AC 400 to 600 V DC	3TX7462-3G 3TX7462-3H 3TX7462-3J 3TX7462-3K 3TX7462-3L	0.01
	3TC52 and 3TC56	压敏电阻式 植入接触器底座或独立安 装	24 to 48 V AC 48 to 127 V AC 127 to 240 V AC 240 to 400 V AC 400 to 600 V DC	3TX7462-3G 3TX7462-3H 3TX7462-3J 3TX7462-3K 3TX7462-3L	0.03
	3TB52 to 3TB56, 5TC52 and 5TC56	压敏电阻式 独立螺钉安装或卡装于 35mm 标准安装导轨	24 to 70 V DC 70 to 150 V DC 150 to 250 V DC	3TX7522-3G 3TX7522-3H 3TX7522-3J	0.03
	3TF68 and 3TF69	压敏电阻式 直流经济型回路, 与辅助 开关并排安装	24 to 70 V DC 70 to 150 V DC 150 to 250 V DC	3TX7572-3G 3TX7572-3H 3TX7572-3J	0.075
	浪涌抑制器 RC 元件				
	3TF30 to 3TF35, 3TF40 to 3TF45, 3TC44 ⁵⁾	RC 元件 线插接式, 安装于线圈端 子	24 to 48 V AC, 24 to 70 V DC 48 to 127 V AC, 70 to 150 V DC 127 to 240 V AC, 150 to 250 V DC 240 to 400 V AC 400 to 600 V DC	3TX7402-3R 3TX7402-3S 3TX7402-3T 3TX7402-3U 3TX7402-3V	0.01
	3TF46 to 3TF51 ³⁾ , 3TC48	RC 元件 与辅助开关并排安装或卡 装于 35mm 标准安装导轨	24 to 48 V AC 24 to 70 V DC 48 to 127 V AC 70 to 150 V DC 127 to 240 V AC 150 to 250 V DC 240 to 400 V AC 400 to 600 V DC	3TX7462-3R 3TX7522-3R 3TX7462-3S 3TX7522-3S 3TX7462-3T 3TX7522-3T 3TX7462-3U 3TX7522-3U 3TX7462-3V	0.075
3TF52 to 3TF56 ³⁾ , 3TB48 and 3TB50, 3TC52 and 3TC56	RC 元件 与辅助开关并排安装或卡 装于 35mm 标准安装导轨	24 to 48 V AC 48 to 127 V AC 127 to 240 V AC 240 to 400 V AC 400 to 600 V AC	3TX7522-3R 3TX7522-3S 3TX7522-3T 3TX7522-3U 3TX7522-3V	0.075	
1) 浪涌抑制器已经集成于下列 3TF 接触器中: 3TF68 和 69: 压敏电阻式 2) 如果保护接触器线圈避免浪涌电压, 开延时可能会增加 (抑制二极管式 6 到 9 倍, 二极管组合式 2 到 6 倍, 压敏电阻式 +2 到 5ms) 3) 不针对直流经济型回路 4) 波幅尖峰值包含在 DC 中 5) 浪涌抑制器的安装部分略有弯曲					

低压控制产品与系统

接触器和接触器组合

3TF交流接触器

技术数据

主触头电寿命 (AC-3):

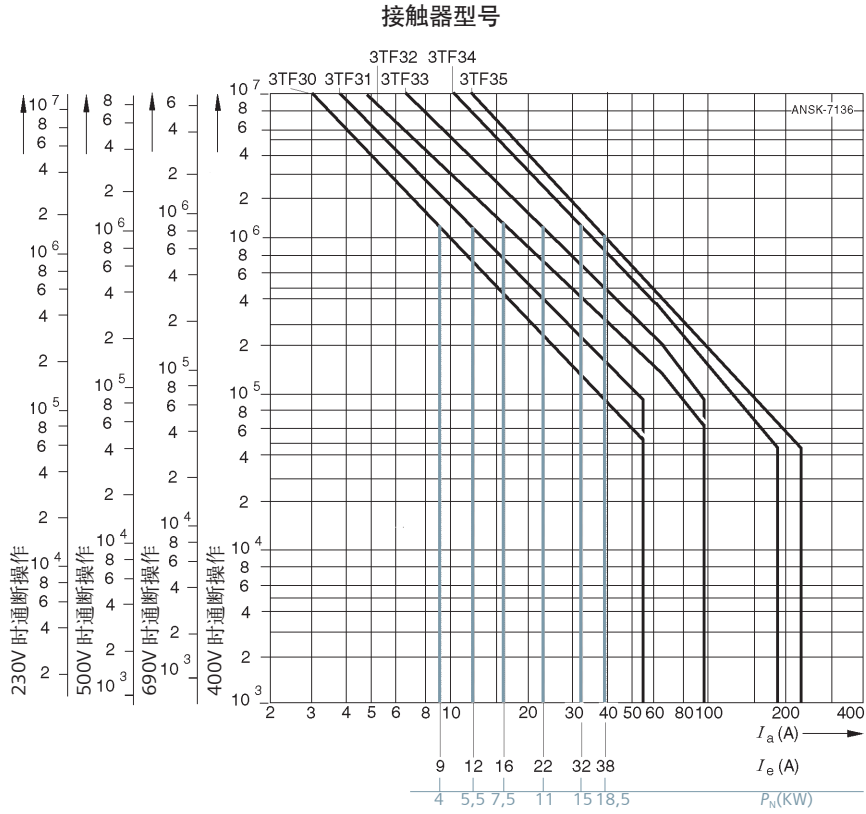

3TF交流接触器

技术数据

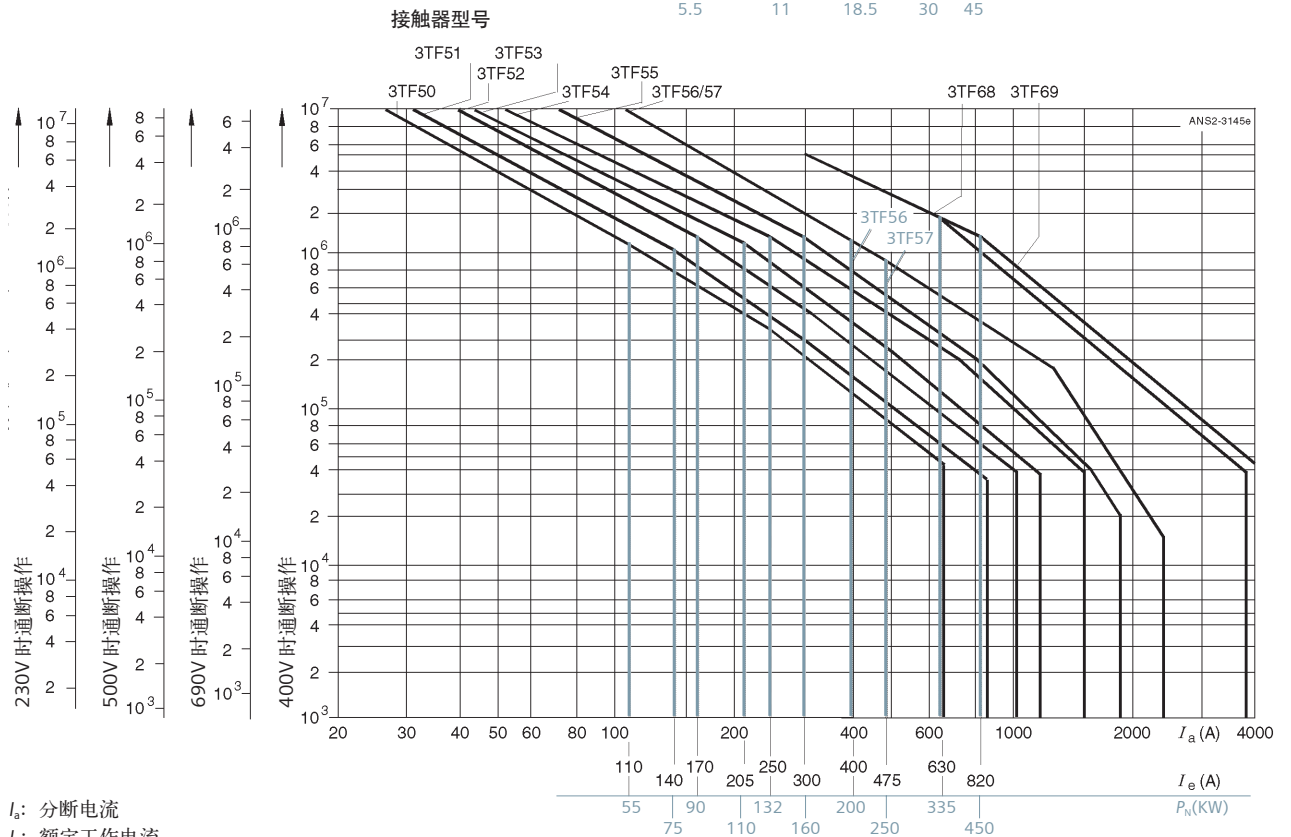
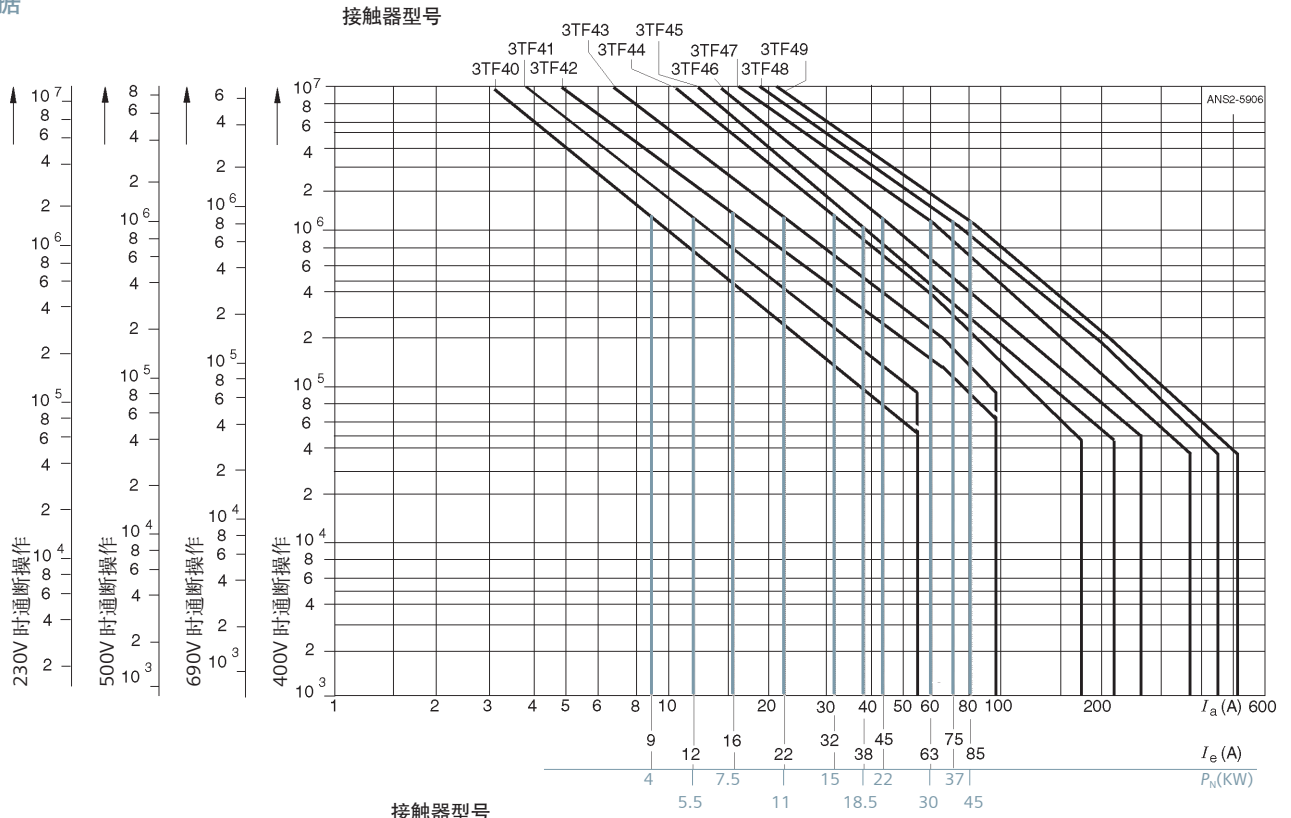

I_a : 分断电流
 I_e : 额定工作电流
 P_N : 三相交流鼠笼电动机的额定功率 (400V)

低压控制产品与系统

接触器和接触器组合

3TF/3TS交流接触器

直流线圈回路

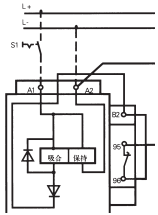

3TF46-3TF51
直流经济电路

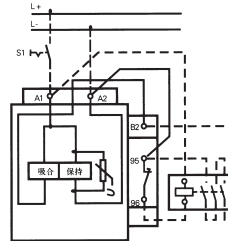

3TF52-3TF56
直流经济电路
由主接触器和切换接触器组成
3TF52 ~ 3TF55 : 3TF40
3TF56 : 3TF42

技术数据

主触头电寿命 (AC-3):

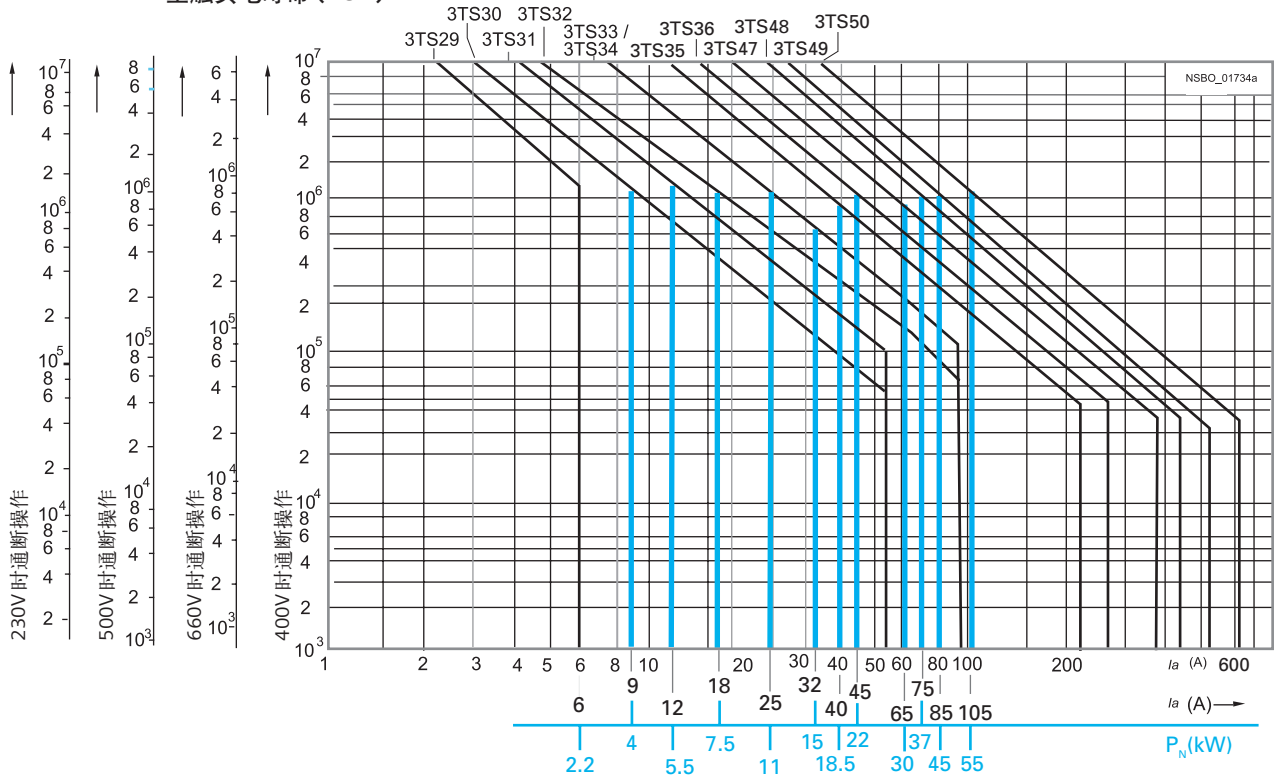

外型及安装尺寸

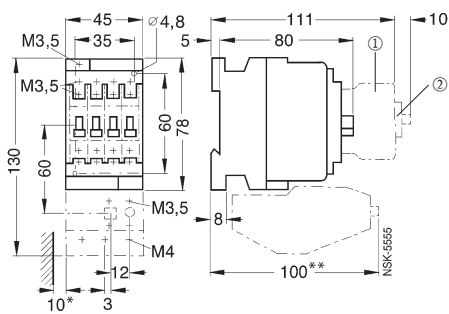

3TS29、3TS30、3TS31、3TS32, 0 级

- ① 3TX3 型辅助触头座
- ② 标志牌

可单独使用，也可与 3US50 配合使用

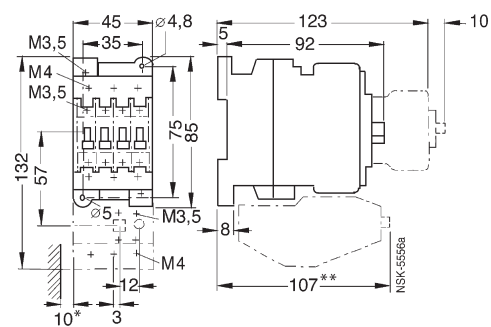

3TS33 和 3TS34, 1 级

可单独使用，也可与 3US55 配合使用

3TS/3TB交流接触器

外型及安装尺寸

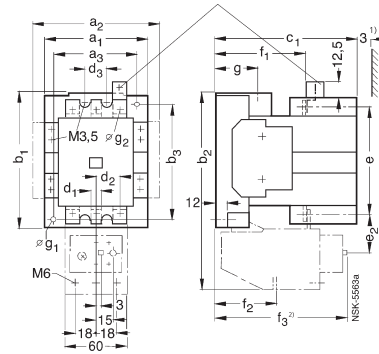
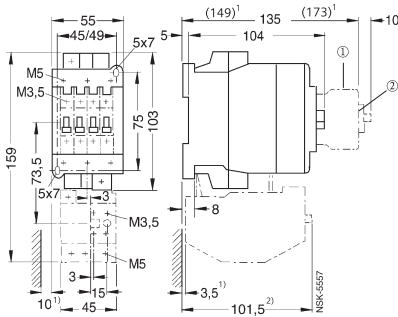

3TS35 和 3TS36, 2 级
可单独使用, 也可与 3US56 配合使用

3TS47 到 3TS50, 3 级和 4 级
可单独使用, 也可与 3US58 配合使用

尺寸	型号	a ₁	a ₂	a ₃	b ₁	b ₂	b ₃	c ₁	(c ₁) ¹	d ₁	d ₂	d ₃	e	e ₂	f ₁	f ₂	f ₃	g	og ₁	og ₂
3	3TS47, 3TS48	90	113	70	117	175	100	123	123	8	26.5	25	94	34	80	63	122	28	4.8	6.1(M6)
4	3TS49	100	123	80	133	194	110	140	140	8	26.5	25	107	36	89	63	122	39	5.5	6.1(M6)
4	3TS50	100	123	80	133	194	110	140	140	10.5	26.5	25	116	31.5	89	63	122	39	5.5	6.1(M6)

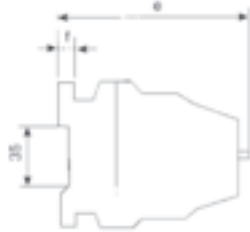
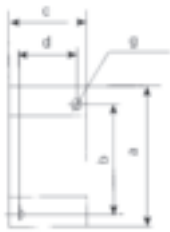

型号	a	b	c	d	e	f	g
3TB40, 3TB41	78	60	45	35	*90 104	7.5	ø5
3TB42, 3TB43	85	75	46	35	114	8	ø5
3TB44	88	75	74	50	108	8	ø5

* 尺寸 90 适用于 3TB4010, 3TB4001, 3TB4110, 3TB4101
尺寸 104 适用于 3TB4022, 3TB4122

技术数据

主触头电寿命 (AC-3):
接触器型号

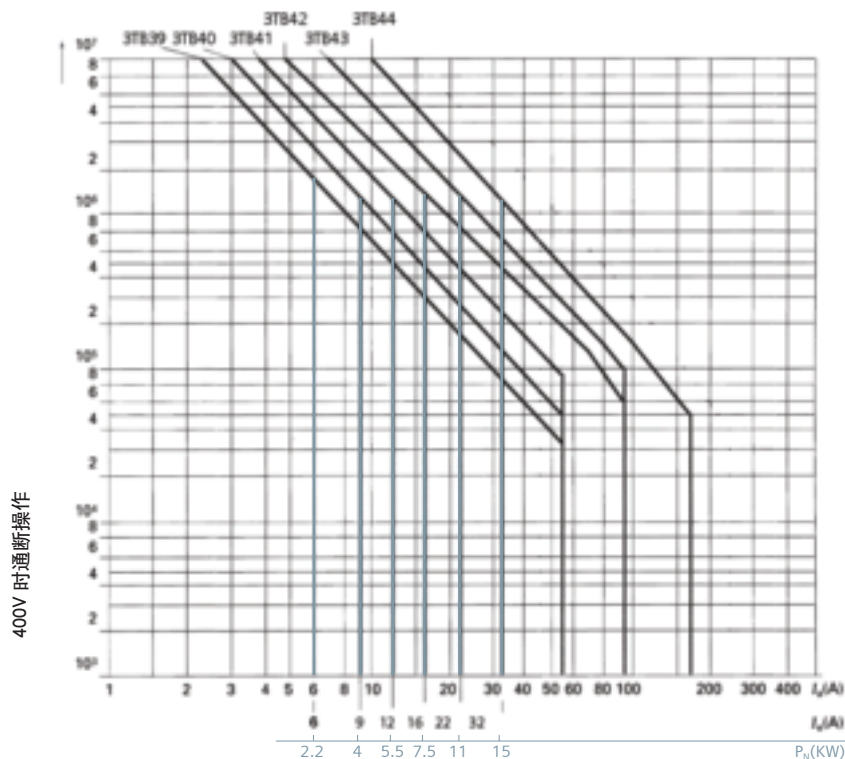

低压控制产品与系统

接触器和接触器组合

3TF交流接触器

外型及安装尺寸

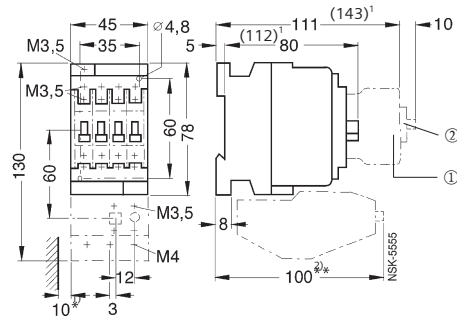

3TF30 和 3TF31, 0 级

- ① 3TX4 型辅助触头座, 带开关位置指示
- ② 标志牌

可单独使用, 也可与 3UA50 配合使用

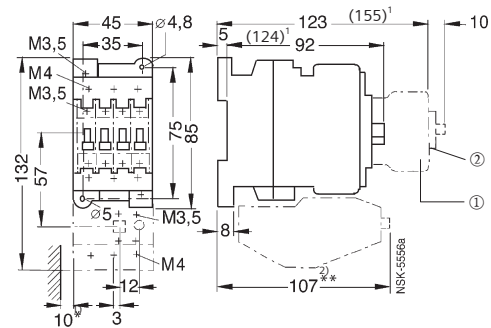

3TF32 和 3TF33, 1 级

可单独使用, 也可与 3UA52 配合使用

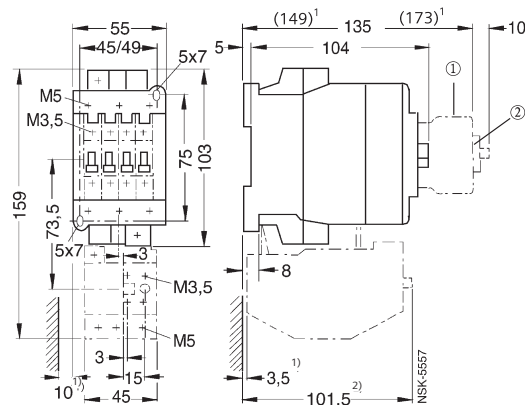

3TF34 和 3TF35, 2 级

可单独使用, 也可与 3UA55 配合使用

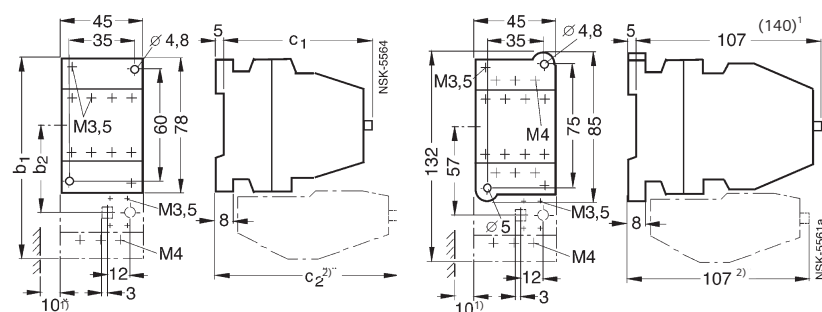

3TF40 和 3TF41, 0 级

可以与 3UA50 或 3UW10 配合使用, 也可单独使用

3TF42 和 3TF43, 1 级

可以与 3UA52 或 3UW13 配合使用, 也可单独使用

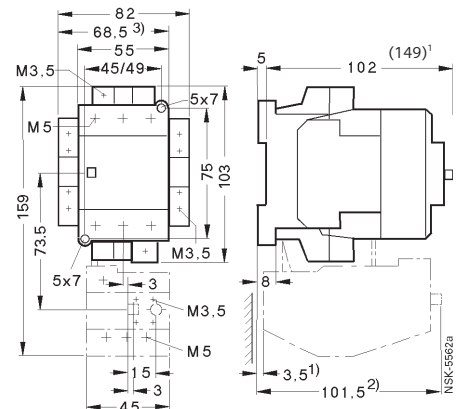

3TF44 和 3TF45, 2 级

可以与 3UA55 配合使用, 也可单独使用

接触器型号	b ₁	b ₂	c ₁	(c ₁) ³	c ₂
1NO 或 1NC	125	55	81	(115) ³	108
1NO+1NC 或 2NO+2NC	130	60	97	(130) ³	100

()³ 直流操作接触器

¹⁾ 离接地体最小间隙

²⁾ 到方形 OFF 按钮 (行程 3mm) 的距离

到圆形 RESET 按钮 (行程 2.5mm) 的距离要小 2.5mm

3TF交流接触器

外型及安装尺寸

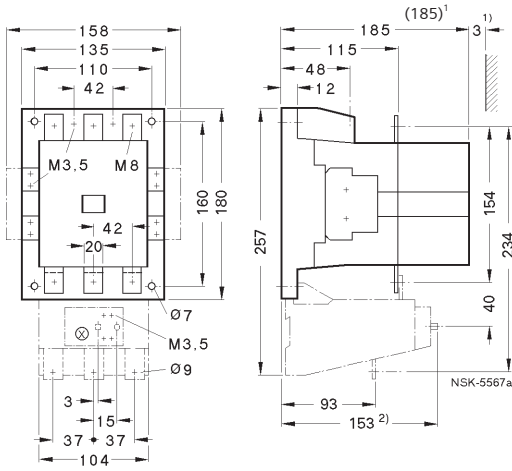

3TF52, 8级

可单独使用, 也可与 3UA62 配合使用

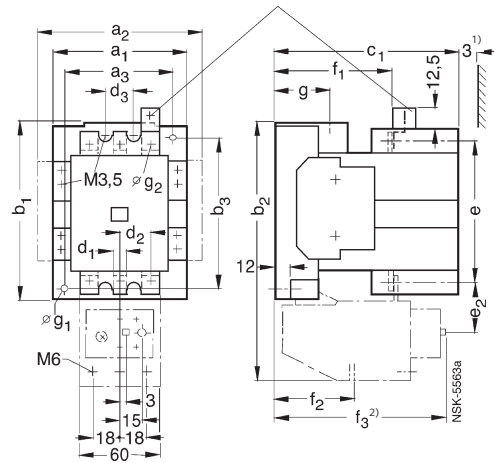

3TF46 到 3TF49, 3级和4级

可与 3UA58 配合使用, 也可单独使用

尺寸	型号	a ₁	a ₂	a ₃	b ₁	b ₂	b ₃	c ₁	(c ₁) ¹⁾	d ₁	d ₂	d ₃	e	e ₂	f ₁	f ₂	f ₃	g	øg ₁	øg ₂
3	3TF46, 3TF47	90	113	70	117	175	100	123	123	8	26.5	25	94	34	80	63	122	28	4.8	6.1(M6)
4	3TF48	100	123	80	133	194	110	140	140	8	26.5	25	107	36	89	63	122	39	5.5	6.1(M6)
4	3TF49	100	123	80	133	194	110	140	140	10.5	26.5	25	116	31.5	89	63	122	39	5.5	6.1(M6)

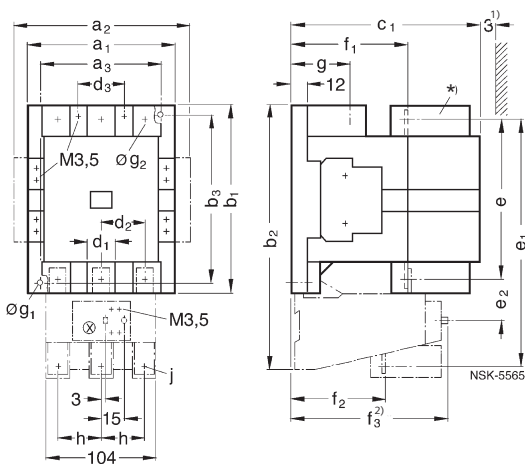

3TF50 和 3TF51, 6级 (3TF50 有端子盒)

可单独使用, 也可与热过载继电器配合使用

3UA60(有端子盒)与 3TF50 相配

3UA61(无端子盒)与 3TF51 相配

型号	h	j
3UA60	37	M6
3UA61	42	M8

* 3TF51 不带端子盒, 作为附件选配

型号	a ₁	a ₂	a ₃	b ₁	b ₂	b ₃	c ₁	(c ₁) ¹⁾	d ₁	d ₂	d ₃	e	e ₁	e ₂	f ₁	f ₂	f ₃	g	øg ₁	øg ₂
3TF50	120	143	100	150	232	130	150	150	15	37	37	130	213	40	93	80	146	45	6.3	6.1(M6)
3TF51	120	143	100	150	232	130	150	150	20	42	37	139	215.5	40.5	93	80	146	45	6.3	9(M8)

()¹⁾ 直流操作接触器

低压控制产品与系统

接触器和接触器组合

3TF交流接触器

外型及安装尺寸

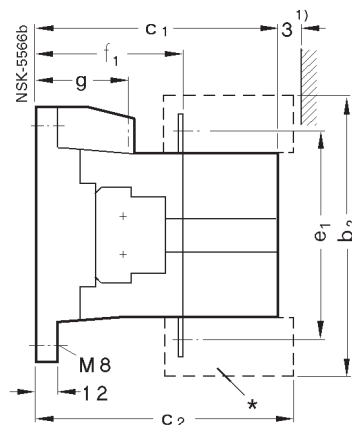
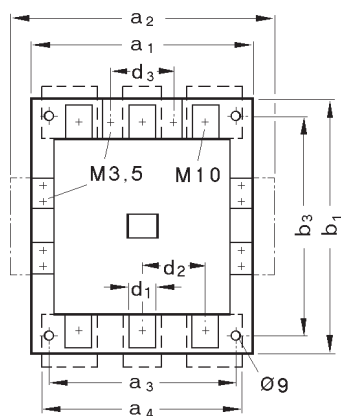

3TF53 到 3TF56, 8~12 级

型号	a ₁	a ₂	a ₃	b ₁	b ₃	c ₁	(c ₁) ¹⁾	e ₁	f ₁	g	d ₁	d ₂	øg ₁
3TF53	135	158	110	180	160	185	185	159	115	48	25	48	7
3TF54, 3TF55	145	168	120	200	180	198	198	168	132	58	25	48	9
3TF56	160	183	130	200	180	222	222	178	150	65	25	48	9

* 端子盒 (附件)

()¹⁾ 直流操作接触器

允许安装位置

接触器必须安装在如下图所示的垂直表面上。

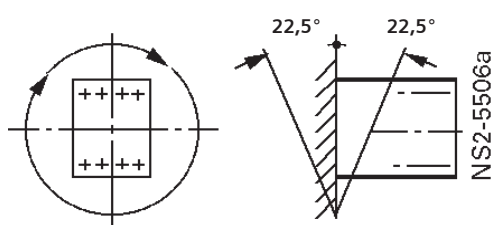

3TF30 - 3TF33 (交流操作)
3TF40 - 3TF43 (交流操作)

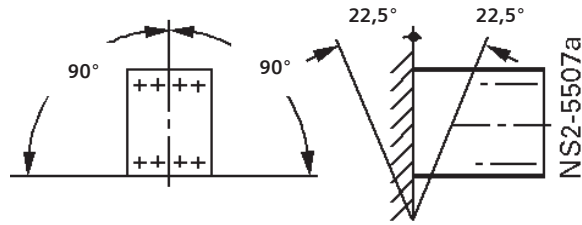

3TF34 - 3TF35 (交流操作)
3TF44 - 3TF56 (交流操作)
3TF30 - 3TF33 (直流操作)
3TF40 - 3TF43 (直流电磁铁系统)
3TF46 - 3TF56 (直流经济回路)

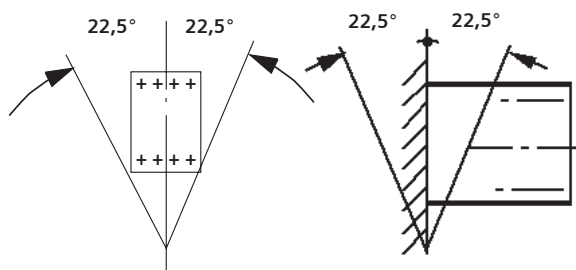

3TF34, 3TF35 (直流操作)
3TF44, 3TF45 (直流螺线管系统)

SANPUM

为高端制造业提供一流的工业产品

SANPUM

深圳木村三浦科技有限公司

地址：深圳市南山区南海大道海王大厦A座19E

电话：86-755-23881000

传真：86-755-23881777

邮箱：info@sanpum.com



4008 824 824
WWW.SANPUM.COM